

## SLIDE SWITCHES

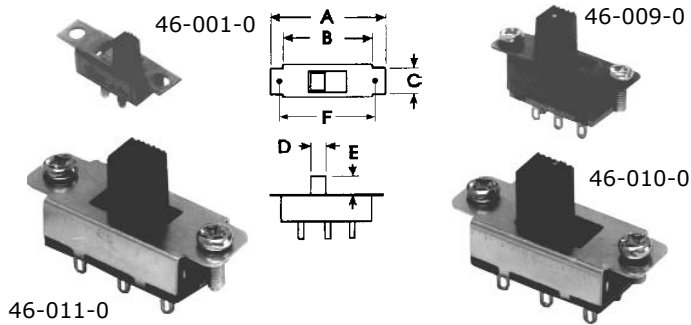

Current ratings are at 125VAC. Dimensions are in mm.

Bulk Part #	Rating	Poles	Switch	A	B	C	D	E
46-001-0	.3A	SPDT	on-on	19	15	5.4	3.2	15
46-009-0	.3A	DPDT	on-on	23	19	7.5	4.5	19
46-010-0	1A	DPDT	on-on	35	28	13	7.0	31
46-011-0	1A	DPDT	on-off-on	38	32	13	7.0	34

Use -2 for Display Package

## ROCKER SWITCHES

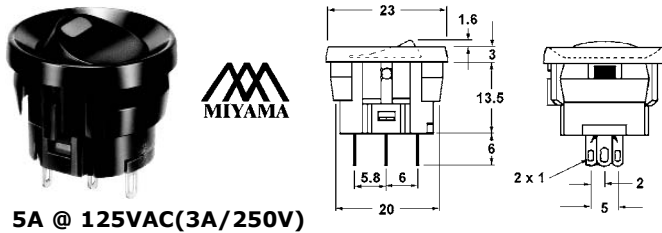

5A @ 125VAC(3A/250V)

Single hole snap-in mount with LED indicator.  
LED requires external limit resistor.

- 46-102-0 SPST on-off black button red LED
- 46-103-0 SPST on-off black button green LED
- 46-104-0 SPST on-off black button yellow LED

Use -1 for Display Package

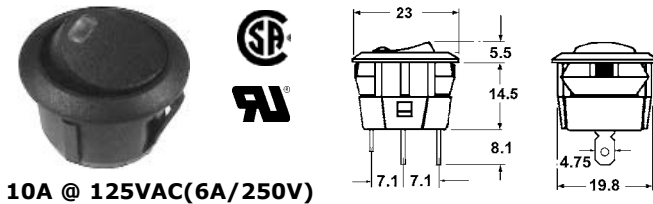

10A @ 125VAC(6A/250V)

Single hole snap-in mount with LED indicator.  
LED requires external limit resistor.

- 46-102J-0 SPST on-off black button red LED
- 46-103J-0 SPST on-off black button green LED
- 46-104J-0 SPST on-off black button yellow LED

Use -1 for Display Package

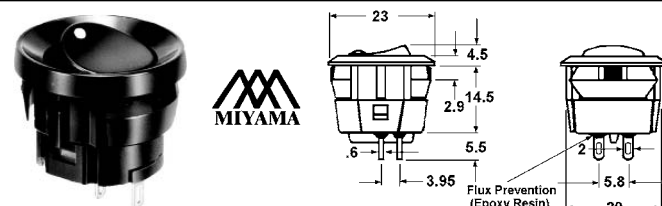

Single hole snap-in mount. 5A @ 125VAC (3A @ 250VAC)

- 46-100-0 SPST on-off black button white dot
- 46-101-0 SPST on-off red button white dot

Use -1 for Display Package

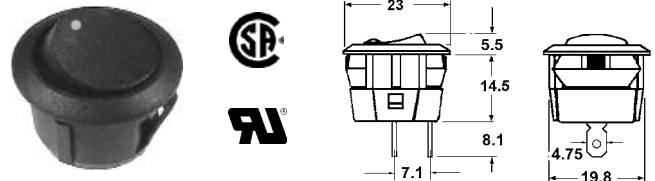

Single hole snap-in mount. 10A @ 125VAC (6A @ 250VAC)

- 46-100J-0 SPST on-off black button white dot

Use -1 for Display Package

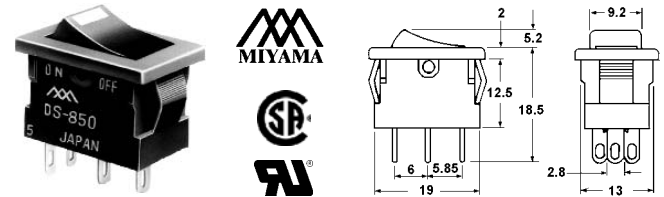

Snap-in mounting 5A @ 125VAC(3A/250V).  
LED requires external limit resistor.

- 46-140-0 SPST on-off red LED indicator
- 46-141-0 SPST on-off green LED indicator

Use -1 for Display Package

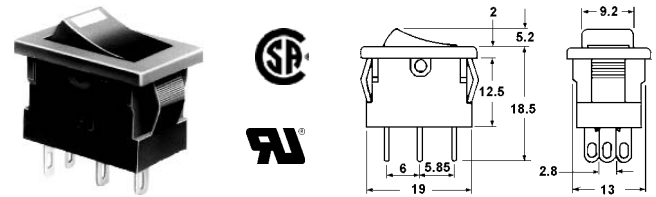

Snap-in mounting 10A @ 125VAC(6A/250V).  
LED requires external limit resistor.

- 46-140J-0 SPST on-off red LED indicator
- 46-141J-0 SPST on-off green LED indicator

Use -1 for Display Package

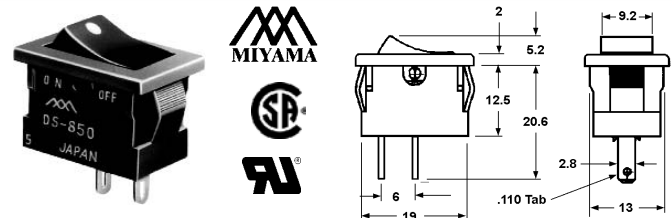

Snap-in mounting 5A @ 125VAC (3A/250V).  
Available with white dot or ON-OFF markings.

- 46-143-0 SPST on-off black button white dot
- 46-144-0 SPST on-off black button ON-OFF

Use -1 for Display Package

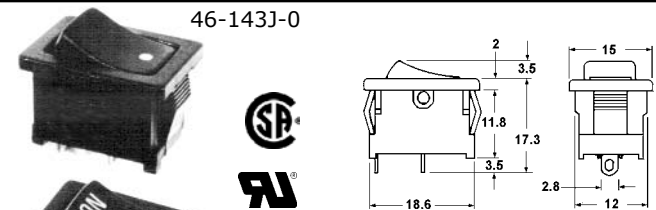

Snap-in mounting

10A @ 125VAC/ (6A/250V)

- 46-143J-0 SPST on-off black button white dot
- 46-144J-0 SPST on-off black button ON-OFF

Use -1 for Display Package

## WEATHERPROOF CAP

Suitable for 46-14x type switches.



- 46-149J-0 Waterproof Cap

Use -5 for Display Package